

CAPACITOR PRODUCT GUIDE



☎ 800-774-4643

🖨 800-768-9782

TABLE OF CONTENTS

VANGUARD START CAPACITORS

MOTOR START CAPACITORS

125 VOLT ROUND CASE.....	2
165 VOLT ROUND CASE.....	3
250 VOLT ROUND CASE.....	3
330 VOLT ROUND CASE.....	4
RECESSED CASE.....	4

MOTOR RUN CAPACITORS

MOTOR RUN CAPACITORS — SINGLE RATED — ROUND

370 VOLT ROUND CASE.....	5
440 VOLT ROUND CASE.....	5
660 VOLT ROUND CASE — BULK PACK.....	6

MOTOR RUN CAPACITORS — DUAL RATED — ROUND

440 VOLT ROUND CASE.....	6
--------------------------	---

MOTOR RUN CAPACITORS — SINGLE RATED — OVAL

370 VOLT OVAL CASE.....	6
440 VOLT OVAL CASE.....	7
660 VOLT OVAL CASE — BULK PACK.....	7
370 VOLT OVAL CASE — BULK PACK.....	7

MOTOR RUN CAPACITORS — DUAL RATED — OVAL

370 VOLT OVAL CASE.....	8
440 VOLT OVAL CASE.....	8

ACCESSORIES

BLEEDER RESISTERS.....	9
BRACKETS (OVAL & ROUND).....	9
BRACKETS (SNAP-IN MOUNTING).....	9
CAPACITOR TESTER (DIGITAL).....	9
END CAPS (LEADS UP & LEADS DOWN).....	9
TERMINAL BOOTS.....	9

VANGUARD START CAPACITORS

- Temperature range -40°C to 65°C
- Suitable for 50 or 60 Cycle
- Plastic case requires no insulation
- (2) 1/4" spade terminals per post
- UL Recognized

MOTOR START CAPACITORS

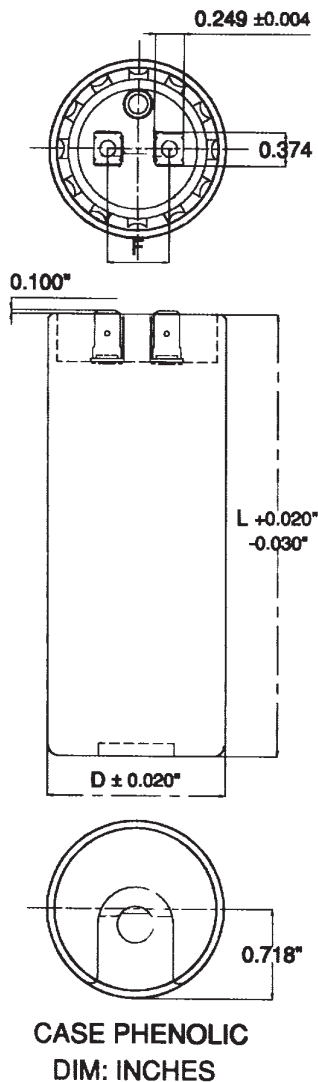

125 VOLT ROUND CASE

MFD	Part Number	Dia.	Height
21-25	BC-21	1 7/16"	2 3/4"
25-30	BC-25	1 7/16"	2 3/4"
30-36	BC-30	1 7/16"	2 3/4"
36-43	BC-36	1 7/16"	2 3/4"
43-53	BC-43	1 7/16"	2 3/4"
53-64	BC-56	1 7/16"	2 3/4"
64-77	BC-64	1 7/16"	2 3/4"
72-88	BC-75	1 7/16"	2 3/4"
88-108	BC-86	1 7/16"	2 3/4"
108-130	BC-108	1 7/16"	2 3/4"
124-149	BC-124	1 7/16"	2 3/4"
130-156	BC-130	1 7/16"	2 3/4"
145-175	BC-145	1 7/16"	2 3/4"
161-193	BC-161	1 7/16"	2 3/4"
189-227	BC-189	1 7/16"	2 3/4"
200-240	BC-200	1 7/16"	2 3/4"
216-259	BC-216	1 7/16"	2 3/4"
243-292	BC-243	1 7/16"	2 3/4"
270-324	BC-270	1 7/16"	2 3/4"
300-360	BC-300	1 7/16"	2 3/4"
324-388	BC-324	1 7/16"	2 3/4"
324-388	BC-324-S	1 13/16"	3 3/8"
334-401	SLF-6	1 7/16"	2 3/4"
340-408	BC-340	1 13/16"	3 3/8"
378-440	BC-378	1 13/16"	3 3/8"
400-480	BC-400	1 13/16"	3 3/8"
437-525	SLF-7	1 7/16"	3 3/8"
460-552	BC-460	1 13/16"	3 3/8"
540-648	BC-540	1 13/16"	4 3/8"
540-648	BC-540-S	1 13/16"	2 3/8"
590-708	BC-590	1 13/16"	4 3/8"
590-708	BC-590-S	1 7/16"	2 3/8"
708-849	BC-705	2 1/16"	4 3/8"
710-852	BC-705-S	1 13/16"	2 3/8"
829-994	BC-800	2 1/16"	4 3/8"
815-978	BC-815	1 13/16"	4 3/8"
1000-1200	BC-1000	2 1/16"	4 3/8"
1175-1400	BC-1175	2 1/16"	4 3/8"

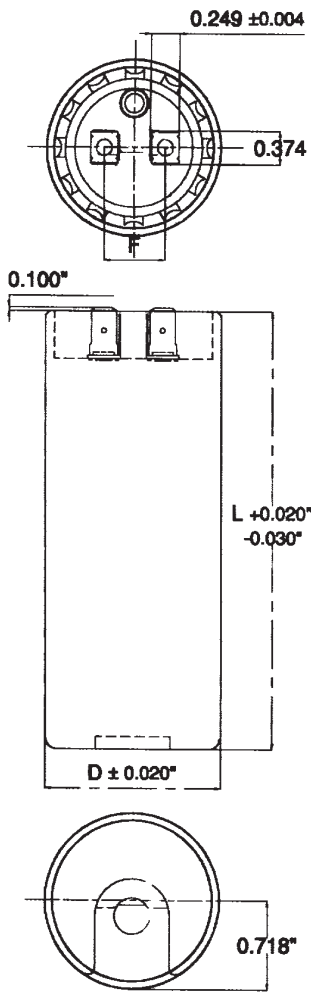

**CASE PHENOLIC
DIM: INCHES**

165 VOLT ROUND CASE

MFD	Part Number	Dia.	Height
108-130	BC-108M-165	1 7/16"	3 3/8"
124-149	BC-124M-165	1 7/16"	3 3/8"
145-175	BC-145M-165	1 7/16"	3 3/8"
161-193	BC-161M-165	1 13/16"	3 3/8"
189-227	BC-189M-165	1 13/16"	3 3/8"
233-280	BC-233M-165	1 13/16"	3 3/8"
243-292	BC-243M-165	1 13/16"	3 3/8"
270-324	BC-270M-165	1 13/16"	3 3/8"
340-408	BC-340M-165	1 13/16"	4 3/8"
378-453	BC-340M-165	1 13/16"	4 3/8"
400-480	BC-400M-165	1 13/16"	4 3/8"
710-852	BC-710M-165	2 1/16"	4 3/8"
815-978	BC-815M-165	2 1/16"	4 3/8"
1020-1264	BC-1020M-165	2 9/16"	4 3/8"

250 VOLT ROUND CASE

MFD	Part Number	Dia.	Height
21-25	BC-21M-250	1 7/16"	2 3/4"
25-30	BC-25M-250	1 7/16"	2 3/4"
30-36	BC-30M-250	1 7/16"	2 3/4"
36-43	BC-36M-250	1 7/16"	3 3/8"
36-43	BC-36M-250-S	1 7/16"	2 3/4"
43-53	BC-43M-250	1 7/16"	3 3/8"
47-56	BC-47M-250	1 7/16"	3 3/8"
53-64	BC-53M-250	1 7/16"	3 3/8"
64-77	BC-64M-250	1 13/16"	3 3/8"
64-77	BC-64M-250-S	1 7/16"	2 3/4"
72-88	BC-72M-250	1 13/16"	3 3/8"
88-108	BC-88M-250	1 13/16"	3 3/8"
108-130	BC-108M-250	1 13/16"	3 3/8"
124-149	BC-124M-250	1 13/16"	3 3/8"
130-156	BC-130M-250	1 13/16"	3 3/8"
145-175	BC-145M-250	2 1/16"	3 3/8"
161-193	BC-161M-250	1 13/16"	4 3/8"
189-227	BC-189M-250	2 1/16"	4 3/8"
216-259	BC-216M-250	2 1/16"	4 3/8"
233-280	BC-233M-250	2 1/16"	4 3/8"
270-324	BC-280M-250	2 1/16"	4 3/8"
340-408	BC-340M-250	2 1/16"	4 3/8"
400-480	BC-400M-250	2 9/16"	4 3/8"

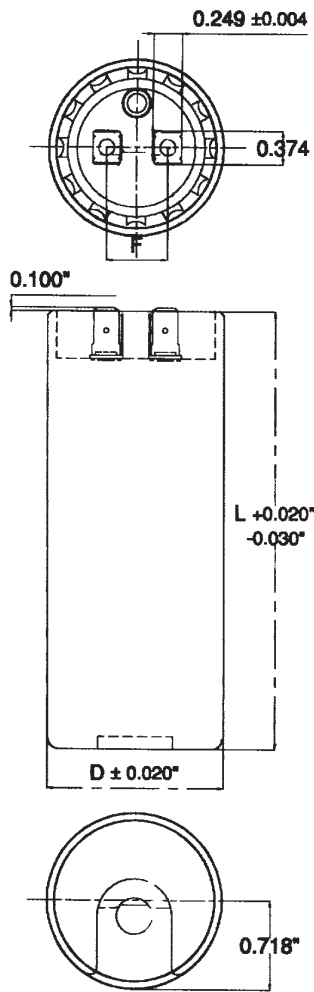

CASE PHENOLIC
DIM: INCHES

330 VOLT ROUND CASE

MFD	Part Number	Dia.	Height
21-25	BC-21M-330	1 7/16"	3 3/8"
25-30	BC-25M-330	1 7/16"	3 3/8"
30-36	BC-30M-330	1 13/16"	3 3/8"
36-43	BC-36M-330	1 13/16"	3 3/8"
43-53	BC-43M-330	1 13/16"	3 3/8"
53-64	BC-54M-330	1 13/16"	3 3/8"
64-77	BC-64M-330	1 13/16"	3 3/8"
72-88	BC-72M-330	1 13/16"	4 3/8"
88-108	BC-88M-330	2 1/16"	3 3/8"
88-108	BC-88M-330-S	1 13/16"	4 3/8"
108-130	BC-108M-330	2 1/16"	4 3/8"
124-149	BC-124M-330	2 1/16"	4 3/8"
130-156	BC-130M-330	2 1/16"	4 3/8"
145-174	BC-145M-330	2 9/16"	4 3/8"
161-193	BC-161M-330	2 9/16"	4 3/8"
189-226	BC-189M-330	2 9/16"	4 3/8"
216-259	BC-216M-330	2 9/16"	4 3/8"
270-324	BC-270M-330	2 9/16"	4 3/8"

RECESSED CASE

MFD	Part Number	Dia.	Height
159-191	BC-159-REC	2 1/16"	4 3/8"
250-300	BC-250-REC	2 1/16"	4 3/8"
43-52	BC-43M-250-REC	2 1/16"	4 3/8"
59-71	BC-59M-250-REC	2 1/16"	4 3/8"
86-103	BC-86M-250-REC	2 1/16"	4 3/8"
105-126	BC-105M-250-REC	2 1/16"	4 3/8"

MOTOR RUN CAPACITORS



- Temperature range -40°C to 70°C
- Suitable for 50 or 60 Cycle
- Metal case
- 1/4" spade terminals
- UL Recognized Pressure Sensitive Interrupter

MOTOR RUN CAPACITORS — SINGLE RATED — ROUND

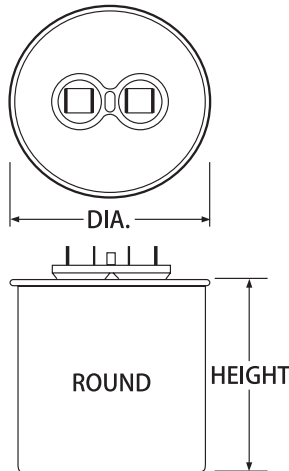

370 VOLT ROUND CASE

MFD	Part Number	Dia.	Height
5	RD-5-370	1 3/4"	2 7/8"
7.5	RD-7.5-370	1 3/4"	2 7/8"
10	RD-10-370	1 3/4"	2 7/8"
12.5	RD-12.5-370	1 3/4"	2 7/8"
15	RD-15-370	1 3/4"	2 7/8"
17.5	RD-17.5-370	1 3/4"	2 7/8"
20	RD-20-370	1 3/4"	2 7/8"
22.5	RD-22.5-370	1 3/4"	2 7/8"
25	RD-25-370	1 3/4"	2 7/8"
30	RD-30-370	1 3/4"	2 7/8"
30 **	5VR0303	1 3/4"	2 7/8"
35	RD-35-370	1 3/4"	2 7/8"
40	RD-40-370	1 3/4"	2 7/8"
45	RD-45-370	2"	2 7/8"
50	RD-50-370	2"	2 7/8"
55	RD-55-370	2"	4 3/4"
60	RD-60-370	2 1/2"	2 7/8"

** Not individually boxed.

"Cross Section Views" Interrupter Protective Device

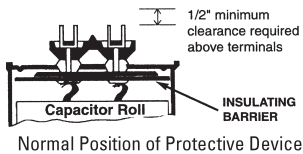

Normal Position of Protective Device

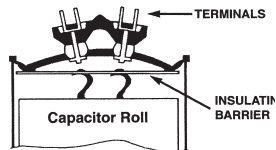

Position of Protective Device After Activation

440 VOLT ROUND CASE

MFD	Part Number	Dia.	Height
10	RD-10-440	1 3/4"	2 7/8"
12.5	RD-12.5-440	1 3/4"	2 7/8"
15	RD-15-440	1 3/4"	2 7/8"
17.5	RD-17.5-440	1 3/4"	2 7/8"
20	RD-20-440	1 3/4"	3 7/8"
25	RD-25-440	1 3/4"	3 7/8"
30	RD-30-440	2"	3 7/8"
35	RD-35-440	2"	3 7/8"
40	RD-40-440	2"	3 7/8"
45	RD-45-440	2 1/2"	3 7/8"
50	RD-50-440	2 1/2"	3 7/8"
55	RD-55-440	2 1/2"	4 3/4"
60	RD-60-440	2 1/2"	4 3/4"
70	RD-70-370	2 1/2"	4 3/4"
75	RD-75-370	2 1/2"	5 1/4"



660 VOLT ROUND CASE — BULK PACK *

MFD	Part Number	Dia.	Height
10	BP-RD-10-660	1 3/4"	2 7/8"
20	BP-RD-20-660	1 3/4"	3 3/4"
25	BP-RD-25-660	2"	3 3/4"
30	BP-RD-30-660	2 1/2"	3 3/4"
40	BP-RD-40-660	2 1/2"	3 3/4"
50	BP-RD-50-660	2 1/2"	4 3/4"

* Contact inside sales representative for standard bulk carton quantities.

MOTOR RUN CAPACITORS — DUAL RATED — ROUND

440 VOLT ROUND CASE

MFD	Part Number	Dia.	Height
30/5	RD-30/5-440	2"	3 7/8"
30/7.5	RD-30/7.5-440	2"	3 7/8"
35/5	RD-35/5-440	2"	4 3/4"
35/7.5	RD-35/7.5-440	2"	4 3/4"
40/5	RD-40/5-440	2"	4 3/4"
40/7.5	RD-40/7.5-440	2"	4 3/4"
45/5	RD-45/5-440	2 1/2"	3 7/8"
50/10	RD-50/10-440	2 1/2"	4 3/4"
50/5	RD-50/5-440	2 1/2"	4 3/4"
50/7.5	RD-50/7.5-440	2 1/2"	4 3/4"
55/5	RD-55/5-440	2 1/2"	4 3/4"

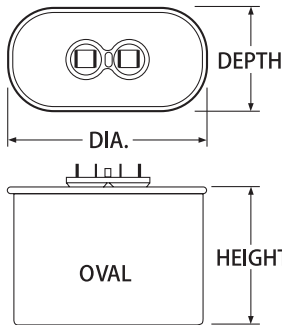
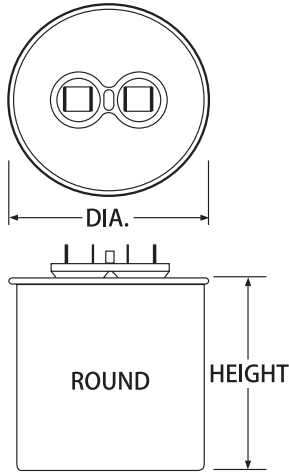

MOTOR RUN CAPACITORS — SINGLE RATED — OVAL

370 VOLT OVAL CASE

MFD	Part Number	Dia.	Height	Depth
2	OV-2-370	2 5/32"	2 1/8"	1 5/16"
3	OV-3-370	2 5/32"	2 1/8"	1 5/16"
4	OV-4-370	2 5/32"	2 1/8"	1 5/16"
5	GE-OV-5-370	2 5/32"	1 1/2"	1 5/16"
6	OV-6-370	2 5/32"	2 1/8"	1 5/16"
7.5	GE-OV-7.5-370	2 5/32"	2 1/8"	1 5/16"
10	GE-OV-10-370	2 5/32"	2 7/8"	1 5/16"
12.5	OV-12.5-370	2 5/32"	3 7/8"	1 5/16"
15	OV-15-370	2 5/32"	3 7/8"	1 5/16"
17.5	OV-17.5-370	2 29/32"	2 7/8"	1 29/32"
20	OV-20-370	2 29/32"	2 7/8"	1 29/32"
25	OV-25-370	2 29/32"	2 7/8"	1 29/32"
30	OV-30-370	2 29/32"	2 7/8"	1 29/32"
35	OV-35-370	2 29/32"	3 7/8"	1 29/32"
40	OV-40-370	2 29/32"	3 7/8"	1 29/32"
45	OV-45-370	3 21/32"	2 7/8"	1 31/32"
50	OV-50-370	3 21/32"	2 7/8"	1 31/32"
55	OV-55-370	3 21/32"	2 7/8"	1 31/32"
60	OV-60-370	3 21/32"	2 7/8"	1 31/32"

"Cross Section Views" Interrupter Protective Device

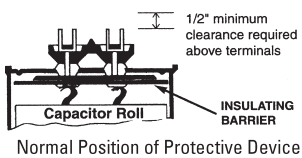

Normal Position of Protective Device

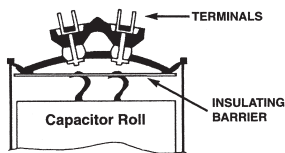

Position of Protective Device After Activation

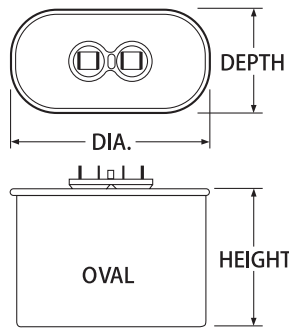

**"Cross Section Views"
Interrupter Protective Device**

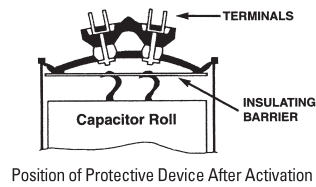
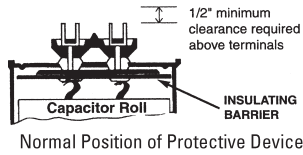

370 VOLT OVAL CASE — BULK PACK (48 PC PER CARTON)

MFD	Part Number	Dia.	Height	Depth
5	GE-BP-OV-5-370	2 5/32"	1 1/2"	1 5/16"
7.5	GE-BP-OV-7.5-370	2 5/32"	2 1/8"	1 5/16"
10	GE-BP-OV-10-370	2 5/32"	2 1/8"	1 5/16"

440 VOLT OVAL CASE

MFD	Part Number	Dia.	Height	Depth
2	OV-2-440	2 5/32"	2 1/8"	1 5/16"
3	OV-3-440	2 5/32"	2 1/8"	1 5/16"
4	OV-4-440	2 5/32"	2 7/8"	1 5/16"
5	OV-5-440	2 5/32"	2 7/8"	1 5/16"
6	OV-6-440	2 5/32"	2 7/8"	1 5/16"
7.5	OV-7.5-440	2 5/32"	3 7/8"	1 5/16"
10	OV-10-440	2 5/32"	3 7/8"	1 5/16"
12.5	OV-12.5-440	2 5/32"	3 7/8"	1 5/16"
15	OV-15-440	2 29/32"	2 7/8"	1 29/32"
17.5	OV-17.5-440	2 29/32"	2 7/8"	1 29/32"
20	OV-20-440	2 29/32"	2 7/8"	1 29/32"
25	OV-25-440	2 29/32"	2 7/8"	1 29/32"
30	OV-30-440	2 29/32"	3 7/8"	1 29/32"
35	OV-35-440	2 29/32"	3 7/8"	1 29/32"
40	OV-40-440	2 29/32"	3 7/8"	1 29/32"
45	OV-45-440	2 29/32"	4 3/4"	1 29/32"
50	OV-50-440	3 21/32"	3 7/8"	1 31/32"
55	OV-55-440	3 21/32"	4 3/4"	1 31/32"
60	OV-60-440	3 21/32"	4 1/4"	1 31/32"

440 VOLT OVAL CASE

MFD	Part Number	Dia.	Height	Depth
10	BP-OV-10-660	2 11/16"	3 1/4"	1 9/16"
20	BP-OV-20-660	2 29/32"	3 3/4"	1 29/32"
25	BP-OV-25-660	2 29/32"	4 1/4"	1 29/32"
30	BP-OV-30-660	2 29/32"	4 3/4"	1 29/32"
35	BP-OV-35-660	3 21/32"	4 1/4"	1 31/32"
40	BP-OV-40-660	3 21/32"	4 1/4"	1 31/32"
45	BP-OV-45-660	3 21/32"	4 1/4"	1 31/32"
50	BP-OV-50-660	3 21/32"	4 3/4"	1 31/32"
60	BP-OV-60-660	3 21/32"	4 3/4"	1 31/32"

* Contact inside sales representative for standard bulk carton quantities.

MOTOR RUN CAPACITORS — DUAL RATED — OVAL

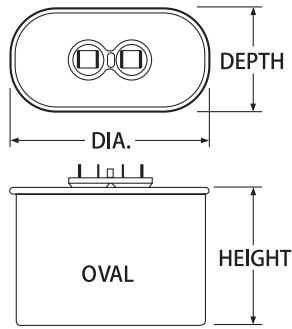

**“Cross Section Views”
Interrupter Protective Device**

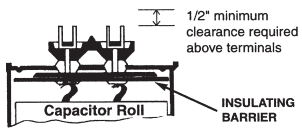

Normal Position of Protective Device

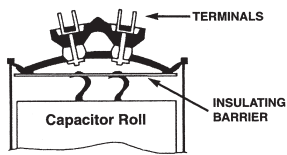

Position of Protective Device After Activation

370 VOLT OVAL CASE

MFD	Part Number	Dia.	Height	Depth
15/10	OV-15/10-370	2 29/32"	2 7/8"	1 29/32"
15/3	OV-15/3-370	2 29/32"	2 7/8"	1 29/32"
15/4	OV-15/4-370	2 29/32"	2 7/8"	1 29/32"
15/5	OV-15/5-370	2 29/32"	2 7/8"	1 29/32"
17.5/4	OV-17.5/4-370	2 29/32"	2 7/8"	1 29/32"
20/10	OV-20/10-370	2 29/32"	3 7/8"	1 29/32"
20/15	OV-20/15-370	2 29/32"	3 7/8"	1 29/32"
20/4	OV-20/4-370	2 29/32"	2 7/8"	1 29/32"
20/5	OV-20/5-370	2 29/32"	2 7/8"	1 29/32"
25/10	OV-25/10-370	2 29/32"	2 7/8"	1 29/32"
25/4	OV-25/4-370	2 29/32"	2 7/8"	1 29/32"
25/5	OV-25/5-370	2 29/32"	2 7/8"	1 29/32"
30/4	OV-30/4-370	2 29/32"	3 7/8"	1 29/32"
30/5	OV-30/5-370	2 29/32"	3 7/8"	1 29/32"
30/7.5	OV-30/7.5-370	2 29/32"	3 7/8"	1 29/32"
35/3	OV-35/3-370	2 29/32"	3 7/8"	1 29/32"
35/4	OV-35/4-370	2 29/32"	4 1/4"	1 29/32"
35/5	OV-35/5-370	2 29/32"	3 7/8"	1 29/32"
40/5	OV-40/5-370	2 29/32"	3 7/8"	1 29/32"
45/5	OV-45/5-370	2 29/32"	3 7/8"	1 29/32"
50/5	OV50/5-370	2 29/32"	4 3/4"	1 29/32"
55/5	OV-55/5-370	3 21/32"	4 3/4"	1 31/32"
60/5	OV-60/5-370	3 21/32"	5 3/4"	1 31/32"
60/7.5	OV-60/7.5-370	3 21/32"	5 3/4"	1 31/32"
80/5	OV-80/5-370	3 21/32"	5 3/4"	1 31/32"
80/7.5	OV-80/7.5-370	3 21/32"	5 3/4"	1 31/32"

440 VOLT OVAL CASE

MFD	Part Number	Dia.	Height	Depth
10/5	OV-10/5-440	2 29/32"	2 7/8"	1 29/32"
17.5/7.5	OV-17.5/7.5-440	2 29/32"	3 7/8"	1 29/32"
20/15	OV-20/15-440	2 21/32"	3 7/8"	1 31/32"
20/5	OV-20/5-440	2 29/32"	2 7/8"	1 29/32"
25/5	OV-25/5-440	2 29/32"	3 7/8"	1 29/32"
30/4	OV-30/4-440	2 29/32"	3 7/8"	1 29/32"

ACCESSORIES



END CAPS (LEADS DOWN)

Diameter	Stock#
1 7/16"	BCH-1
1 13/16"	BCH-2
2 1/16"	BCH-3
2 9/16"	BCH-15

END CAPS (LEADS UP)

Diameter	Stock#
1 7/16"	BCH-25
1 13/16"	BCH-26
2 1/16"	BCH-27
2 9/16"	BCH-28



OVAL & ROUND

BRACKETS – ROUND

Used On	Stock#
2" Round	RAC-201

BRACKETS - OVAL

Used On	Stock#
1 5/16" Oval	RAC-1516
1 31/32" Oval	RAC-131
2 29/32" Oval	RAC-200

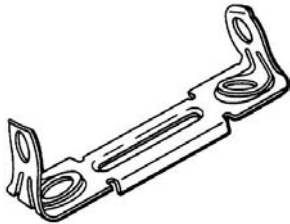

SNAP-IN MOUNTING BRACKETS

Capacitor Length	Stock#
2 3/4"	BCH-16
3 3/8"	BCH-4
4 3/8"	BCH-5

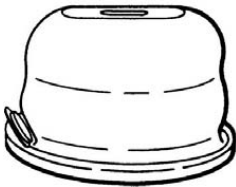

TERMINAL BOOTS

Description	Stock#
One Lead Hole	RAC-RG-1
Two Lead Hole	RAC-RG-2



COMPOSITION BLEEDER RESISTERS

Description	Stock#
Motor Start 15000 ohms 2 watts	RAC-RG-3-10PK (10 per pack)



DIGITAL CAPACITOR TESTER

Description	Stock#
Digital Capacitor Tester	MFD-10

- Measures the capacitance value on start and run capacitors from .01 to 10,000 MFD
- Checks for open and shorted capacitors - tells when capacitors are weak
- Use as a continuity tester
- Checks Run, Start & DC Electrolytic capacitors
- Identifies unmarked capacitors
- Includes handy carrying case
- Test clips store in the durable case



BRANCH LOCATIONS:

Birmingham, AL	Charlotte, NC	Chicago, IL	Denver, CO	Edison, NJ
Fort Wayne, IN	Houston, TX	Lubbock, TX	McAllen, TX	McDonough, GA
Memphis, TN	Oklahoma City, OK	Ontario, CA	Philadelphia, PA	Portland, OR
Salt Lake City, UT	Simcoe, ON	Tampa, FL	Tempe, AZ	Torreon, Mexico



www.essexbrownell.com